

Articolo / Article

COD.

Struttura Uni 50 nero matt con cassetto
BLACK MATT Framework Uni 50 with drawer

Finitura quercia / Oak wooden finish

MSTBN501 ..

Finitura bianco matt / matt white finish

MSTB503 ..

Finitura Nero matt / matt black finish

MSTB502 ..



Lucidi / Shiny

Opachi / Matt

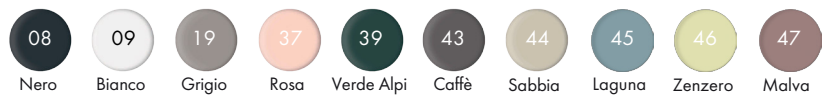
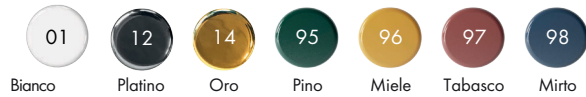

Materia / Materia

Colorato / Coloured

Specificare il colore al momento dell'ordine

Specify the color when ordering

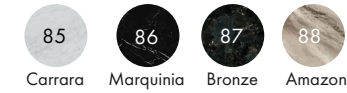

.....::

cm 50x50x76

kg 22

pallet ita

pallet ex

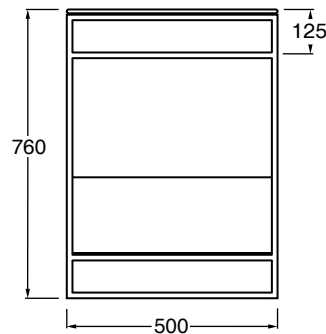
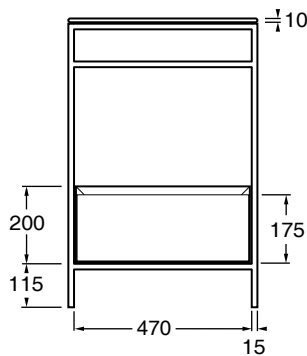
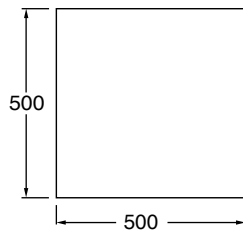

Accessori / Accesories

COD.

COD.



Sifone tondo in ottone finitura cromo
Round brass siphon chrome finish

SIF01



Sifone tondo in ottone finitura nero matt
Round brass siphon black matt finish

SIF01N

TECNICAL SHEET n°: 94	DESIGNER: ALICE	CODE: MSTBN50101		
SHEET FORMAT: A4	ISO	REVISION: 00	SCALE: 1:20	DATE: 10/05/2024
REGULATION:				Pg: 1/1
All the measurements respect the tollerances provided by the Alice Ceramica srl.				

Alice Ceramica srl
Via Sassacci, 17 - 01033
Civita Castellana (VT), Italy
Tel [+39] 0761.598.328 [+39] 0761.513.252
Fax [+39]0761.540.352
www.aliceceramica.com - info@aliceceramica.it

